



Rechargeable Lithium battery Operation and Maintenance manual

Description

This manual describes in detail the requirements and procedures for safe installation and operation of RUIXU lithium battery system. Please read this manual carefully, only qualified persons are allowed to install, operate and maintain the system, otherwise it may cause product damage or personal safety risks.

Any actions against safety operation, or do not follow rules of this manual and limited warranty letter, will void warranty and qualification of this product. Meanwhile, the manufacturer will be not responsible for the product damage, property damage, personal injury or even death.

The information contained in this manual is accurate when it's issued. RUIXU reserve right to change specification (such as optimization, upgrade or other operations) without prior notice, please always view the latest document via QR code on the label.

In addition, please noted that the diagrams/schematics in this document are used to help understand system configuration and installation instructions, which may be different from the actual items at the installation.

Content

1.Information	1
1.1 Disclaimer.....	1
1.2 Target Group	3
1.3 Levels of warning messages	3
1.4 Symbol Description	4
1.5 Abbreviation Description.....	6
2. Safety	7
2.1 Safety precautions.....	7
2.2 Safety instructions	8
2.2.1 General Requirements.....	8
2.2.2 Emergency safety measures	9
2.2.3 Other Tips	9
2.3 Electrical safety	10
2.3.1 Grounding requirements	10
2.3.2 AC and DC operation requirements.....	10
2.3.3 Wiring requirements	11
2.4 Installation environment requirements	12
2.5 Mechanical safety	13
2.5.1 Lifting safety.....	14
2.5.2 Heavy lifting safety.....	15
2.6 Equipment safety	16
2.7 Battery installation specification.....	18
2.8 Personnel requirements.....	19
2.9 Others.....	19
3. Product introduction	20
3.1 Product profile	20
3.1.1 Dimension.....	21
3.1.2 Parameters.....	21
3.2 Features.....	23
3.3 Component description.....	24
3.3.1 Link IN / Link OUT	25
3.3.2 Inverter brand.....	26
3.3.3 Power switch.....	27
3.3.4 Indicator light.....	27
3.3.5 LED flashing description	29
3.3.6 Display screen.....	29
3.4 Protection.....	31
3.5 Emergency Power Off.....	32
4 Pre-installation preparation	33
4.1 Installation environment	33
4.2 Tool and instrument preparation	34
4.3 Dismantling of packaging	35
4.4 Checking components.....	36
4.4.1 Scope of delivery	36

4.4.2 External cable kits.....	37
5 Installation.....	38
5.1 Matters need attention.....	38
5.2 Battery mounted.....	39
6. Cable connection and commissioning	42
6.1 Cable connection.....	42
6.2 Commissioning.....	47
6.3 Switch off battery.....	47
6.4. Troubleshooting	47
6.4. Fuse replacement	49
7. Transport, Storage	50
8. Disposal of battery	50
Appendix I.....	51
Appendix II	53

1.Information

This document is valid for: RUIXU Lithi2-16 battery system.when transporting, storing,installing, operating and maintaining the equipment, please read this manual first and strictly follow all safety precautions marked on the equipment and in the manual.

1.1 Disclaimer

The "Caution", "Warning", "Statement" and "Danger" items in the manual do not represent all safety matters to be observed. It is only a supplement to all safety precautions. RUIXU does not assume any liability for violations of general safety requirements or violations of safety standards for the design, manufacture and use of the equipment.

RUIXU(“the Seller”) warrants each RUIXU branded battery (“the Product”), as listed below, sold by RUIXU or any of its authorized distributors or dealers, to be free of defects for the period as listed in the table below (“the Warranty Period”), from the date of sale as determined by either the customers’ sale receipt, the shipping invoice and/or the battery serial number, with proof of purchase. Within the Warranty Period, subject to the exclusions listed below, the Manufacturer will credit, replace or repair, if serviceable, the Product and/or parts of the Product, if the components in question are determined to be defective in material or workmanship.

The Warranty Period for Physical Goods purchased from RUIXU Battery is 10 Years.RUIXU Battery will replace or repair the product at no charge, using new or refurbished replacement parts.

The Seller has no obligation under this limited warranty for product subjected to the following conditions (including but not limited to):

- Damage caused during shipping or mishandling of the Product
- Damage due to improper installation:loose terminal connections, under-sized cabling, incorrect series (cannot be used in series) or parallel connections, reverse polarity connections, or insufficient space for airflow
- Environmental damage such as inappropriate storage conditions as defined by the Manufacturer, exposure to extreme hot or cold temperatures, fire or freezing, or water damage, impact, or collision

- Damage due to improper operation or maintenance such as under- or over-charging the Product, cold temperature charging, lack of cleaning resulting in corroded terminal connections or build-up of dirt, debris, organic matter, fossil fuels, or chemicals on the Product casing
- Improper use of CAN cables such as improper connections or not connecting them
- Installing CAN communication devices that do not follow the appropriate CANbus guidelines as defined by the Manufacturer
- Product that has been opened, modified, or tampered with Tampering or removal of manufacture date codes.
- Product that was used for applications other than which it was designed and intended for by the Manufacturer
- Product that was under-sized for the application.

This Limited Warranty does not cover a Product that has reached its normal end of life due to usage which may occur prior to the Warranty Period. A battery can deliver only a fixed amount of Energy over its life which will occur over different periods of time depending on the application. The Manufacturer reserves the right to deny a warranty claim if the Product is determined, upon inspection, to be at its normal end of life even if within the Warranty Period.

Submitting A Warranty Claim

To submit a warranty claim, please contact the original place of purchase. The Product may be required to be shipped back to the Seller for further inspection. The Product must be shipped in compliance with UN38.3. Please note that DOT requires all persons' shipping batteries to be Hazmat certified.

Technical Support

If you have technical questions about the Product, please contact the place of purchase or RUIXU Battery directly at techsupport@ruixubattery.com

1.2 Target Group

This document is intended for qualified persons and operators. Only qualified persons are allowed to perform the activities marked in this document with a warning symbol and the caption "Qualified person". Qualified persons must have the following skills:

- Knowledge of how lithium iron phosphate batteries work and are operated.
- Knowledge of how an energy storage system (including PV/battery/hybrid inverter, MPPT, Meter, Distribution box etc.) works and is operated.
- Knowledge of local applicable connection requirements, standards, and directives.
- Training in the installation and commissioning of electrical devices, batteries.
- Training in how to deal with the dangers and risks associated with installing, repairing and using electrical devices, batteries.

1.3 Levels of warning messages

The following levels of warning messages may occur when handling the product

DANGER

Indicates a hazardous situation which, if not avoided, will result in death or serious injury.

WARNING

Indicates a hazardous situation which, if not avoided, could result in death or serious injury.

CAUTION











Indicates a hazardous situation which, if not avoided, could result in minor or moderate injury or product permanent damage.

NOTICE

Indicates a situation which, if not avoided, can result in property damage or product not work or accelerated product damage





1.4 Symbol Description

Symbols on products label

Label	Definition
	Beware of electrical shock
	Beware of battery leakage
	Beware of heavy objects
	Beware of explosion
	Beware of toppling
	Pay attention to the positive and negative battery terminals
	Do not place the battery within children/pet touchable area.
	Do not place the battery near heat source and flammable material
	Do not expose the battery to direct sunlight, rain and snow.
	The UL1973 certificate label for Safety by Intertek

	The certificate label for European EMC directives
UN38.3	The certificate label for UN38.3

Other symbols

Label	Definition
 Qualified person	Indicates activities that can only be performed by qualified persons
	Grounding point
	Recycle label
	WEEE designation
	Do not short circuit the battery

1.5 Abbreviation Description

Abbreviation	Definition
Battery/battery pack/battery module	Single RUIXU Lithi2-16 rechargeable lithium iron phosphate battery pack including cells, BMS and enclosure etc.
Battery system/cluster	Multiple RUIXU Lithi2-16 battery pack connected in parallel with power, communication and grounding cables and installation auxiliaries.
BMS	Full name:Battery management system Electronical Unit to ensure lithium cells' safety and display information or control the battery work mode.
SOC	Full name:State of Charge The battery state of charge refers to the percentage of the remaining capacity and rated capacity of the battery.
SOH	Full name:State of health The battery health status refers to the percentage between the full charged capacity and the rated capacity of the battery.

2. Safety

2.1 Safety precautions

DANGER

Explosion risk

- Do not impact the battery with heavy objects.
- Do not squeeze or pierce the battery system.
- Do not throw the battery system into the fire.

WARNING

Fire risk

- Do not expose the battery system to the condition over 80°C.
- Do not put the battery near a heat source, such as a fireplace.
- Do not expose the battery system to direct sunlight or raining.

CAUTION

Electric shock risk

- Do not allow non-qualified person to disassemble the battery system.
- Do not touch the battery system with wet hands.
- Do not expose the battery system to moisture or liquid environment.

NOTICE

Damage risk

- Do not short-circuit or reverse connect the battery.
- Do not use chargers or charging devices unapproved by the manufacturer to charge the battery.
- Do not mix batteries from different manufacturers or different kinds, types or brands.

The battery has been designed and tested in accordance with international (such as UL, IEC, UN38.3 etc.) safety requirements. However, Due to various factors during the whole lifetime process, RUIXU cannot guarantee absolute safety, in order to prevent personal injury and property damage and ensure long-term operation of the battery, please do read and following the below section carefully to operate the battery and handle emergency situations

2.2 Safety instructions

2.2.1 General Requirements

- It is strictly prohibited to install, use and operate outdoor equipment and cables (including but not limited to handling equipment, operating equipment and cables, plugging and unplugging signal interfaces connected to the outdoors, working at height, outdoor installation, etc.) in inclement weather such as lightning, rain, snow and force 6 winds.

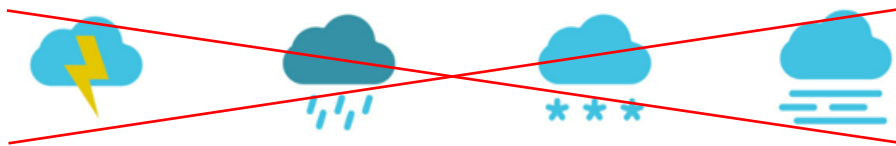

- It is strictly forbidden to wear watches, bracelets, bangles, rings, necklaces and other easily conductive objects during installation, operation and maintenance to avoid burns by electric shock.
- Special protective gear must be used during installation, operation and maintenance, such as wearing insulated gloves, goggles, and safety shoes, as shown below.



Insulated gloves



Safety Glasses



Safety Shoes

- Installation, operation and maintenance must be performed in the order of the steps in the instruction manual.
- In case of fire, evacuate the building or equipment area and press the fire alarm, or call the fire alarm. Re-entry into a burning building is strictly prohibited under any circumstances.
- It is strictly prohibited to artificially alter, damage or obscure the logo and nameplate on the equipment. The installation process is strictly forbidden to operate with electricity.
- It is forbidden to use water to clean the Battery system.
- In the process of equipment operation, if a fault is found that may lead to personal injury or equipment damage, the operation should be immediately terminated, reported to the person in charge, and effective protective measures should be taken.
- To avoid the risk of electric shock, it is prohibited to connect a Safety Extra Low Voltage (SELV) circuit to a Communication Network Voltage (TNV) circuit.
- Do not power up the equipment until installation is complete or without professional confirmation.

2.2.2 Emergency safety measures

WARNING

In case of fire situations, before using the fire extinguishing device, ensure that the fire extinguishing device can be used for electrical fires.

Water invasion

To ensure safety, disconnect the micro circuit breaker on the right side of the battery system and evacuate to a safe position

Electrolyte or gas leakage

If the battery system leaks electrolyte, avoid contact with the leaking liquid or gas. If one is exposed to the leaked substance, immediately perform the actions described below.

- **Gas Inhalation:** Evacuate the people in the contaminated area and seek medical aid immediately.
- **Eye Contact:** Flush your eye with clean and flowing water for 15 min, and seek medical aid immediately.
- **Skin Contact:** Thoroughly rinse the exposed area with soap and water to be sure no chemical or soap is left on them, and seek medical aid immediately.
- **Ingestion:** Induce vomiting, and seek medical help immediately.

2.2.3 Other Tips

- All the product are strictly inspected before shipment, please contact us for replacement if you notice there's any defectives such as swelling.
- Do not disassemble batteries and components, otherwise the manufacturer will not be responsible for any damage caused by unauthorized disassembly or repair.
- Do enable the battery to be safely grounded before use to make sure the system in safe and normal operation.
- Please ensure that the electric parameters of these devices are compatible mutually before connecting the battery to other devices.
- Please take the environmental factors into careful considerations to ensure that the system can work in a suitable condition as the environment and storage methods have a certain impact on the service life and reliability of this product.

2.3 Electrical safety

2.3.1 Grounding requirements

- When installing equipment that requires grounding, the protective grounding wire must be installed first; when dismantling the equipment, the protective grounding wire must be removed in the last step.
- It is forbidden to destroy the grounding conductor.
- It is prohibited to operate the equipment without a grounding conductor installed.
- The equipment should be permanently connected to a protective ground. Before operating the equipment, check the electrical connections to the equipment to ensure that it is reliably grounded.

2.3.2 AC and DC operation requirements

WARNING

It is forbidden to install and remove the power cord with electricity. The moment the power cord core touches the conductor, it will generate an electric arc or spark, which can lead to fire or personal injury.

- Before installing and removing the power cord, the power switch must be turned off.
- Before connecting the power cord, you must make sure the power cord label is correctly marked before connecting it.
- If the power cord is damaged, it must be replaced by the manufacturer, business agent or professional to avoid risk.

2.3.3 Wiring requirements

- Cables used in high temperature environments may cause the insulation layer aging, breakage, cable and heat generating devices or heat source area between the periphery of the distance of at least 500mm.
- The cable should meet the requirements of VW-1 flame retardant grade.
- The same type of cable should be tied together, different types of cable at least 30mm apart, prohibit each other entanglement or cross placement.
- When the temperature is too low, the violent shock and vibration may cause the plastic outer skin of the cable to be brittle and cracked. To ensure construction safety, the following requirements should be followed:

All cables should be laid and installed above 0°C. When handling cables, especially in low-temperature environments, they should be handled gently.

If the cable is stored at an ambient temperature below 0°C, the cable must be moved to room temperature for more than 24 hours before deployment.

- Cable selection, racking and routing must follow local laws and regulations and specifications.

2.4 Installation environment requirements

- It is strictly prohibited to install, use and operate outdoor equipment, cables (including but not limited to handling equipment, operating equipment and cables, plugging and unplugging signal interfaces connected to the outdoors, working at height, outdoor installation, opening doors, etc.) in inclement weather such as lightning, rain, snow, gale force six or higher.
- The equipment should be installed in the area away from the liquid, and it is forbidden to install it under the location of water pipes, air outlets and other locations that are easy to produce condensation; it is forbidden to install it under the location of air conditioning openings, vents, machine room outlet windows and other locations that are easy to leak water, in order to prevent the liquid from entering the inside of the equipment and causing equipment failure or short circuit.
- If liquid is found inside the device, turn off the power immediately and notify the administrator.
- It is forbidden to place the equipment in an environment with flammable or explosive gases or fumes, and to perform any operation in that environment.
- When installing the equipment, make sure that the mounting surface is solid and meets the load-bearing requirements of the equipment.
- It is strictly prohibited to install the equipment in the strong vibration, strong noise sources and strong electromagnetic field interference area.
- Drilling holes in the equipment is strictly prohibited. Drilling will damage the electromagnetic shielding properties of the equipment, internal devices and cables, and the metal chips from drilling into the equipment will cause a short circuit in the circuit board.

2.5 Mechanical safety

WARNING

- Operations carried out at a distance of more than 2 meters from the ground are aerial work.
 - When working at height, you must meet the requirements of local regulations for operating at height.
 - You must go through relevant training and obtain the relevant qualification certificate before you can work at height.
-
- In case of one of the following situations, work at height should be stopped: rainwater has not yet dried, and other situations where danger may occur. When the above situation has passed, the company's safety director and relevant technical personnel must check various operation equipment and confirm the consent before operation.
 - Before working at height, should carefully check the ascent tools and safety appliances, such as helmets, safety belts, ladders, springboards, scaffolding, lifting equipment, etc., if they do not meet the requirements should be immediately improved or refused to work at height. Do a good job of safety protection, wearing helmets, safety belts or waist rope, tied to a solid and sturdy structural components, strictly prohibited to hang on the moving unsecured objects or sharp-edged metal, to prevent hooks from slipping off a fall accident.
 - Work at height site, should be delineated dangerous exclusion zone, set clear signs, strictly prohibit the entry of extraneous personnel.
 - It is strictly forbidden to throw objects from heights to the ground and to throw objects from the ground to heights, and objects should be transmitted using strong ropes, hanging baskets, elevated trucks or cranes.
 - The ground below the aerial work area is strictly forbidden to stack scaffolding, springboards, and other miscellaneous objects. Ground personnel are strictly prohibited to stay or pass directly below the aerial work area.

2.5.1 Lifting safety

- The foundation where the crane operation is carried out must meet the load-bearing requirements of the crane work.
- When lifting heavy objects, it is strictly forbidden to walk under the boom and lifting objects.
- Personnel who carry out lifting operations need to undergo relevant training and be qualified before they are allowed to work.
- Lifting tools need to be inspected and the tools are complete before use.
- Before lifting operations, ensure that lifting tools are firmly fixed to load-bearing fixtures or walls.
- When lifting, it is forbidden to drag the wire rope and spreader and to use hard objects to hit.
- During the lifting process, ensure that the angle between the two cables is not greater than 90° , as shown in the figure below.
- If only two rings are used for lifting, use lifting belts that meet the load-bearing requirements to avoid deformation of the rings.
- If conditions permit, please use a lying way to lift, to ensure that the battery will not be damaged.

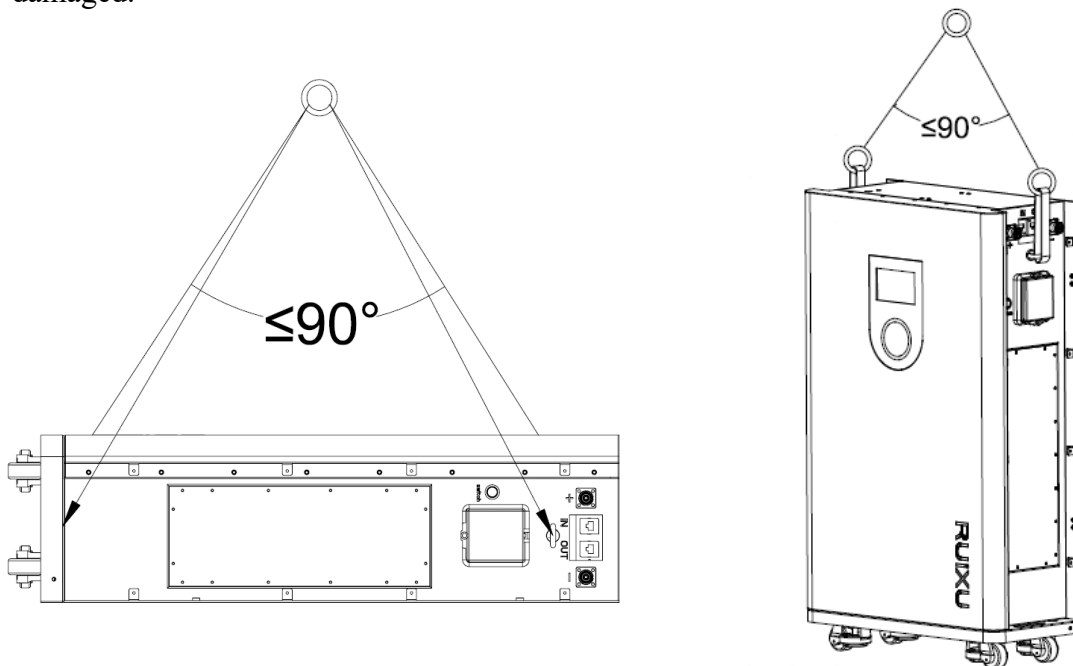

2.5.2 Heavy lifting safety

DANGER

The battery must be moved carefully to avoid any damage to the equipment caused by impacts or drop

- When carrying heavy objects, you should be prepared to bear the weight to avoid being crushed or sprained by heavy objects.

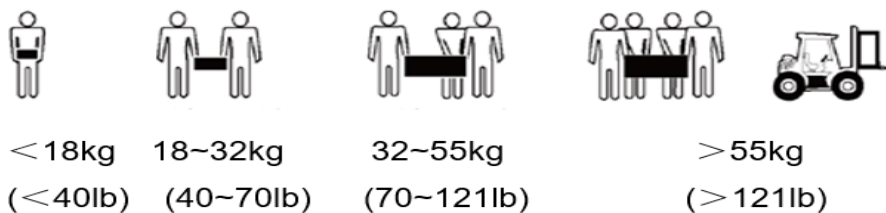

- When handling equipment by hand, you should wear protective gloves, shoes and other safety gear to avoid injury.
- When moving or lifting the device, hold the device by the handle or by the bottom edge of the device, and not by the module already installed in the device.
- The equipment handling process should avoid scratching the surface of the cabinet or damaging the components and cables of the cabinet.
- Before moving, please fasten the equipment to the forklift with ropes; when moving, it needs to be guarded by someone.
- When transporting the equipment, you should try to choose railroad transport, sea transport or road in better condition to ensure the safety of the equipment. Bumps and tilts should be minimized during transport.
- The cabinet must be moved carefully to avoid any damage to the equipment caused by impacts or drop.



2.6 Equipment safety

DANGER

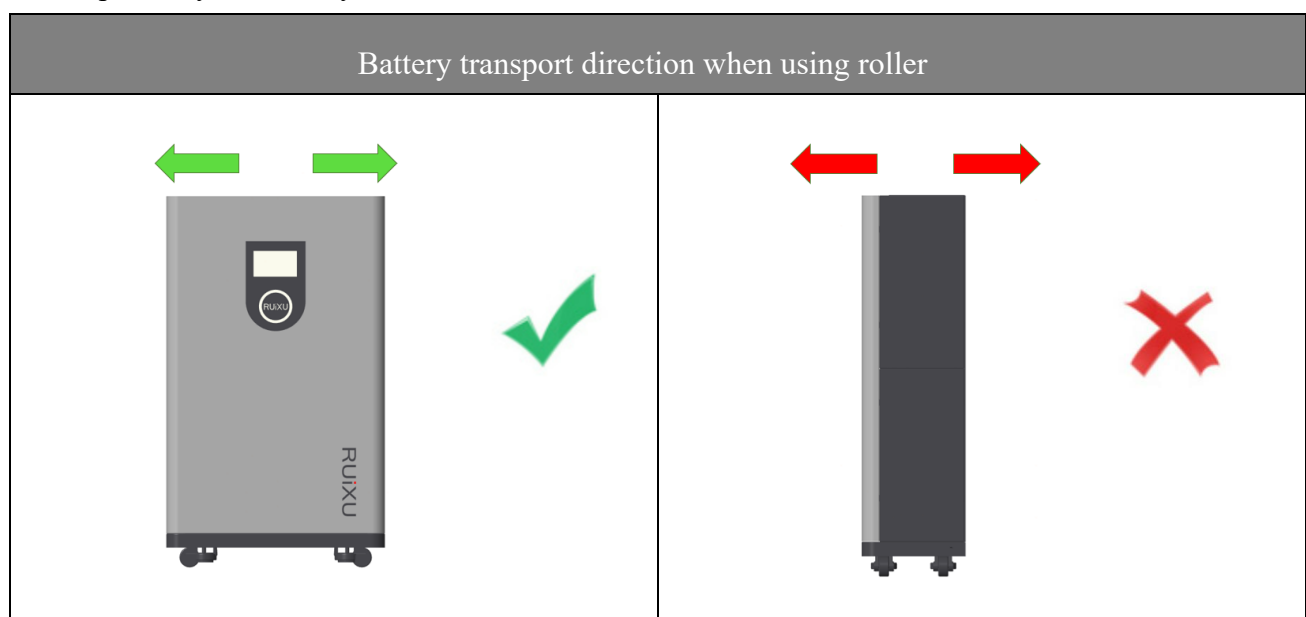
- Do not expose the battery to high temperature environments or around heat generating devices such as sunlight, fire, transformers, heaters, etc.
 - It is strictly prohibited to disassemble, modify or destroy the battery (such as inserting foreign objects, dipping into water or other liquids) to avoid causing battery leakage, overheating, fire or explosion.
-
- Before performing battery work, you must carefully read the safety precautions for the operation and master the correct connection method of the battery.
 - Please use special insulation tools. The battery circuit should be kept disconnected during installation, maintenance and other operations.
 - Please use the specified type of battery, the improper model of battery may lead to battery damage.
 - Please dispose of used batteries according to local laws and regulations, and do not dispose of batteries as household waste. Improper disposal of batteries may lead to battery explosion. When handling the battery,.
 - When using the wheel that comes with the battery, it should be carried in the direction required by the battery.

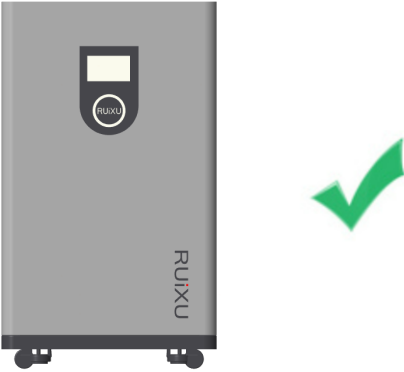

- Transport the battery system in the specified direction. Do not invert or tilt it.

Battery placement direction during transportation	
	
	
	

2.7 Battery installation specification

⚠ NOTICE

Leave a gap of 30cm above the battery for cable routing.

- After removing the package, place the battery in the required direction, forbid to place it upside down, sideways, tilted and stacked, avoid any impact or drop that may cause battery damage and scrap.



Battery placement direction

- The battery installation location should be ventilated, dry and cool environment, away from heat sources, flammable, humid, organic solvents and corrosive gases, etc., and take good fire prevention measures. The battery should be placed horizontally and fixed.
- It is strictly forbidden to place installation tools on the battery during the battery installation.

2.8 Personnel requirements

NOTICE

- Professional: A person who has training or experience in operating equipment and can be aware of the various sources and magnitudes of potential hazards in the installation, operation, and maintenance of equipment.
 - Trained personnel: personnel who have undergone the appropriate technical training and have the necessary experience to be aware of the risks that may be posed to him when carrying out a particular operation and to take measures to minimize the risks to himself or to other personnel.
-
- Only qualified professionals or trained personnel are allowed to install, operate and maintain the equipment.
 - Replacement of equipment or parts (including software) must be done by a professional or trained personnel.

2.9 Others

Transportation, storage maintenance

- For long-term storage, it needs to be charged and discharged once every 3 months in the manner specified in the specification.
- When loading and unloading the battery during transportation, please be careful not to drop it, do not stack more than 3 layers, turn it over, and make sure the front side is facing up.
- To avoid short-circuiting the battery, the battery is not allowed to be connected for maintenance.

Warnings and precautions

- For the safe use and handling of the battery, please read the specifications, user manual and the warning signs on the surface of the battery box carefully before use. Improper use of the battery may cause overheating damage to the battery, RUIXU Battery is not responsible for any accidents caused by not following the correct operation.

3. Product introduction

3.1 Product profile

The RUIXU Lithi2-16 battery is designed for residential application and works as a storage unit in the photovoltaic system. It is a 48V Li-ion battery storage system, with BMS inside itself. It could be operated in both on-grid, back-up and off-grid modes with compatible inverters. Below is the general schematic of an ac-coupled system.

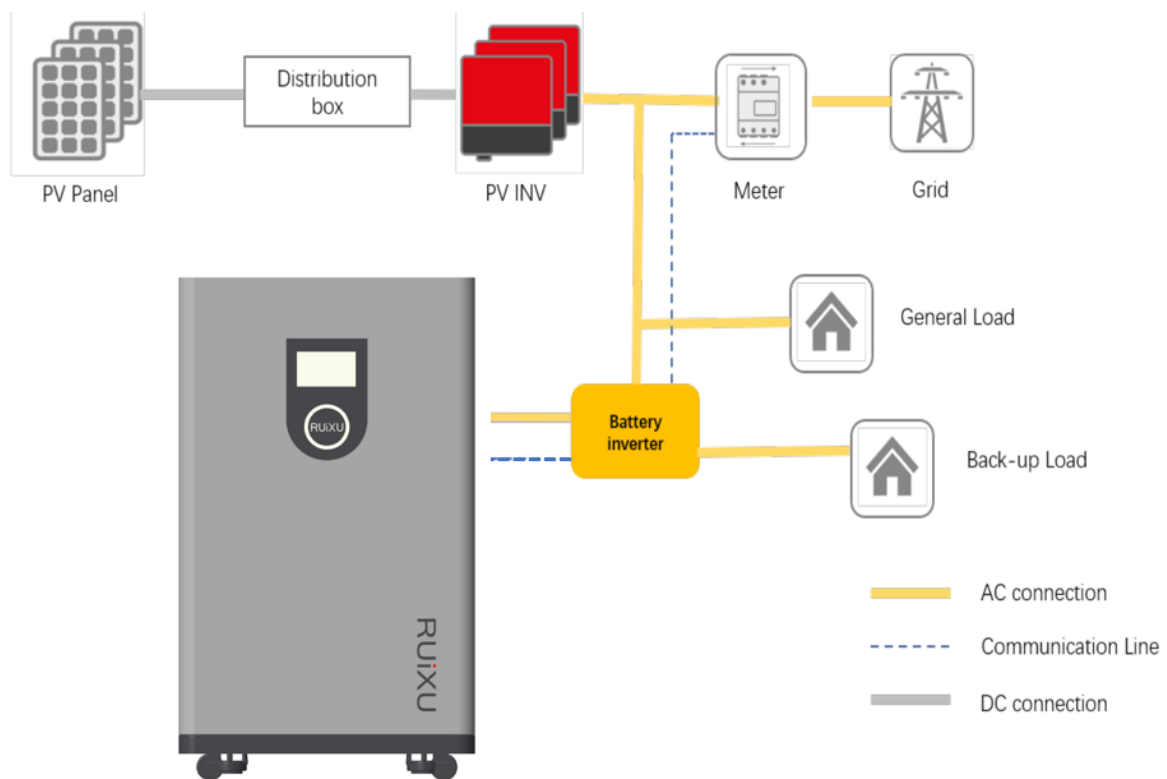

System diagram

⚠ CAUTION

This electrical connection in this diagram is only for illustration, please follow the Manual suggestions of related devices and operate in accordance with locally applicable connection requirements, standards, and directives.

3.1.1 Dimension

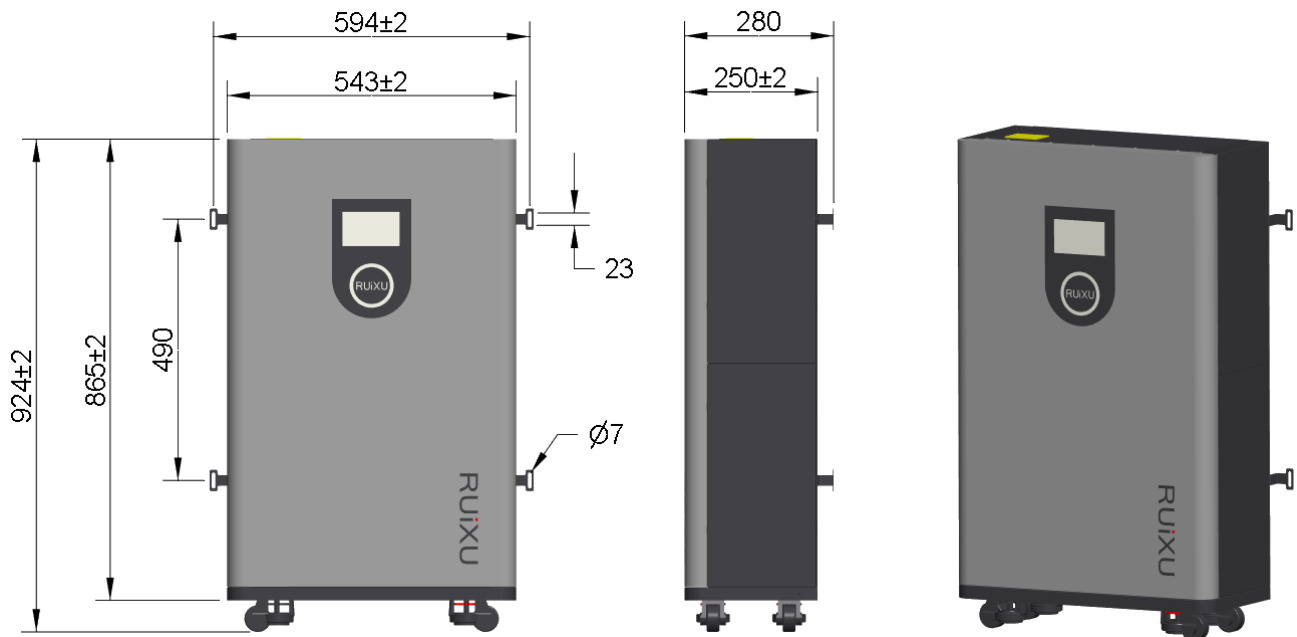

Product appearance and dimensions (unit: mm)

3.1.2 Parameters

Items	RUIXU Lithi2-16
Rated voltage	51.2V
Max. voltage range	43.2~56.8V, Shipping voltage>51.2V
Charge voltage	56.8V
Low voltage cut-off	43.2V
Nominal energy	16.1KWh
Usable energy [1]	16.1KWh
Nominal capacity	314Ah
Dimension	924*543*250mm (36.38*21.38*9.84 inch)
Weight	~137kg (302.0lb)
Standard charge current	≤140A
Max. charge current	200A
Standard discharge current	≤140A
Max. discharge current	200A (initial temp. ≤35°C)
Peak discharge current	220A@15S 360A@1S
Communication	RS485 /CAN

Max parallel number	32pcs	
Operation temperature ¹	Charge: 0~50°C Discharge:-20~50°C	
Storage temperature	0°C<T<30°C	< 6 months
	-10°C<T<45°C	< 3 months
	Recommended environment	15~35°C, 5~75%RH

Note:

[1] Usable energy

Test conditions: 100% depth of Discharge (DOD) ,0.2C rate charge/discharge at 25°C, actual usable energy at the A C output may vary by condition, such as the inverter efficiency and temperature.

NOTICE

- The optimum operating temperature range is from 15°C to 30°C, Frequent exposure to the harsh temperatures may worsen the performance of the battery system and cycle life.
- If the battery systems are connected in parallel, please use bus bars.
- Before connecting the battery system in parallel, ensure that the SOC of the battery system is as consistent as possible

3.2 Features

- Highest safety, battery is made from LiFePO₄ chemistry and comply with highest international safety and transport standard.
- Modular and flexible, support up to 32 batteries connect together to expand the system energy.
- Build-in pre-charge circuit to avoid rush current when connecting with different inverter/chargers.
- Automatic dynamic addressing function when connected multiple batteries together.
- Rapid shut down function for North American market.
- Support a maximum of 96% DOD under off-grid and back-up application
- Built in BMS provide warning and protection functions including over-discharged, over-charged, over-current, short-circuit and high/low temperature.
- LiFePO₄ as cathode material and automatic balancing function to meet long cycle life
- The product comes with a roller, which can be adjusted to a fixed mode or attached to the wall using accessories.
- The product comes with a 5-inch display that monitors battery status in real time.
- The product has 4 quick-detachable decorative panel on the side to protect the battery system and make the product more concise.
- The product comes with 3 layers of protection to make the battery system even more secure.
- and can also add a fire protection device built into the product
- The product comes with self-locking quick-plug terminals, which can effectively prevents loose terminals.
- CAN/RS485 port for external communication and upgrade the BMS firmware.

3.3 Component description

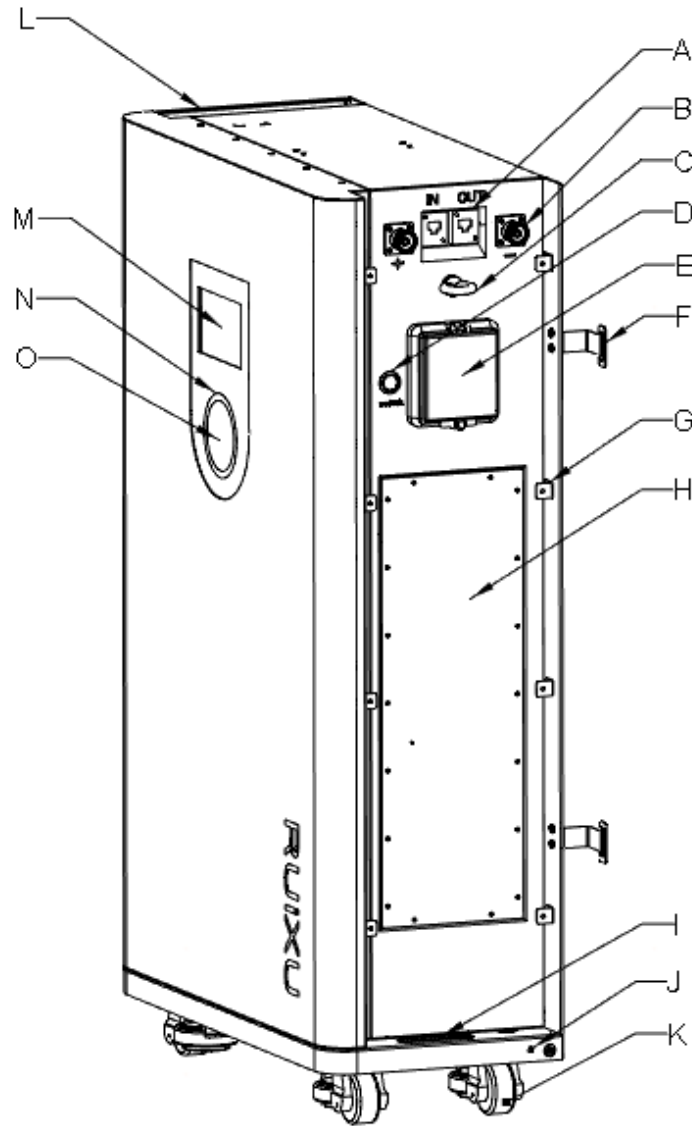

No.	Items	Usage description	Remark
A	Link IN / Link OUT	For internal and external communication	
B	Terminal	Used to connect battery with ground	
C	Hole for hoist	Used to lift the battery	
D	Power switch	Used to Power on/off battery	
E	MCB	Used to protect the battery system	Micro Circuit Breaker
F	Battery accessories	Used to fixed battery	
G	Decorative panel fixed point	Used for fixing decorative plates	

H	Repair window	Used for inspection and maintenance to BMS	
I	Hole for hoist	Used to lift the battery	
J	Grounding	Used to connect battery with ground	
K	Roller	Used to move battery	
L	Decorative panel	Used to protect the battery system and make the product more concise.	Decorative panel (4pcs)
M	Display screen	Displays battery information	5-inch display
N	SOC indicator light	Displays the current battery level	20%/40%/60%/80%100%
O	Status indicator light	Displays the current battery system status	

3.3.1 Link IN / Link OUT

Port	Pin No.	Definition	Remarks
Link OUT	1	RS485-B1	<ol style="list-style-type: none"> Used to connect with external devices to establish communication. Used to connect with upper battery system Link OUT.
	2	RS485-A1	
	3	SGND	
	4	CAN - H	
	5	CAN - L	
	6	/	
	7	RS485-A1	
	8	RS485-B1	
Link IN	1	RS485-B2	<ol style="list-style-type: none"> Used to connect with downward battery system Link OUT. 3 and 6 are scram button connection points
	2	RS485-A2	
	3	Emergency Power Off -	
	4	CAN - H	
	5	CAN - L	
	6	Emergency Power Off +	
	7	RS485-A2	
	8	RS485-B2	

⚠ NOTICE

The BMS contains the CANBUS 120Ω resistance, and the BMS will automatically connect or disconnect the resistance according to the need. It is not necessary to connect the 120Ω resistance when connecting the CANBUS.

3.3.2 Inverter brand

Supported inverter brands

ID	CANBUS Connection	RS485 Connection
1	Victron/SMA/Studer Innotec/Sofar	Voltronic/RCT/MPP/ Alphaoutback
2	RUIXU/Sol-Ark/Solis/Goodwe/Deye/Growatt/SAJ / Megarevo/INVT/Sermatec/ TBB/MUST/Sunsynk/PYLON	SRNE
3	Schneider	PYLON
4	LUXPOWER	/
5	/	Growatt
6	Reserve-1	Reserve-1
7	Reserve-2	Reserve-2
...
10	Reserve-5	Reserve-5

Note: Please refer to Appendix I for the communication connection method.

3.3.3 Power switch

Power on

When the battery system is in hibernation state, hold down the switch for 3S to start the battery system;

Power off

When the battery system is started, hold down the switch for 3S to shut down the battery system;

Battery system reset

When the battery system is on, hold down the button for 10s to reset the battery system;

3.3.4 Indicator light



SOC indicator light										
Mode	Charge					Discharging				
Indicator light	L1	L2	L3	L4	L5	L1	L2	L3	L4	L5
0~20%	Flash2	OFF	OFF	OFF	OFF	ON	OFF	OFF	OFF	OFF
20~40%	ON	Flash2	OFF	OFF	OFF	ON	ON	OFF	OFF	OFF
40~60%	ON	ON	Flash2	OFF	OFF	ON	ON	ON	OFF	OFF
60~80%	ON	ON	ON	Flash2	OFF	ON	ON	ON	ON	OFF
80~100%	ON	ON	ON	ON	Flash2	ON	ON	ON	ON	ON
Sleep mode	OFF					OFF				

Status indicator light								
Mode	Event	Run indicator light		Power indicator light				Description
		●	●	●	●	●	●	
Shutdown	Dormancy	OFF	OFF	OFF	OFF	OFF	OFF	ALL OFF
Standby	Normal	FLASH1	OFF	See section 3.3.4				Standby
	Warning	OFF	OFF					/
Charge	Normal	ON	OFF	See section 3.3.4				/
	Warning	OFF	OFF	(Highest SOC LED: FLASH2)				/
	Full charge protection	ON	OFF	See section 3.3.4				/
	overcurrent protection	FLASH1	OFF	See section 3.3.4				/
Discharge	Normal	FLASH3	OFF	See section 3.3.4				/
	Warning	OFF	OFF	See section 3.3.4				/
	low-voltage protection	OFF	FLASH3	OFF	OFF	OFF	OFF	Stop discharging
	overcurrent protection	OFF	ON	OFF	OFF	OFF	OFF	Stop discharging
Temperature	Protection	OFF	ON	OFF	OFF	OFF	OFF	Stop charging/discharging
Failure	Protection	OFF	ON	OFF	OFF	OFF	OFF	Stop charging/discharging
	Emergency Power Off	OFF	FLASH2	OFF				/

Note: The product LOGO indicates a run indicator light.

3.3.5 LED flashing description

FLASH Type	ON	OFF
FLASH1	0.25S	3.75S
FLASH2	0.5S	0.5S
FLASH3	0.5S	1.5S

3.3.6 Display screen

Abbreviation	Definition
VOL	Voltage of battery or system
CUR	Electric current of battery or system
Battery QTY	Quantity of online batteries in the system
Info	Battery system details information
Charge MOS / Discharge MOS	Charge Mosfet in BMS / Discharge Mosfet in BMS
Temp MAX / Temp MIN	Maximum temperature / Minimum temperature
Total dischar energy	Total discharge energy of the battery system
Equalization	Battery system voltage balancing mode

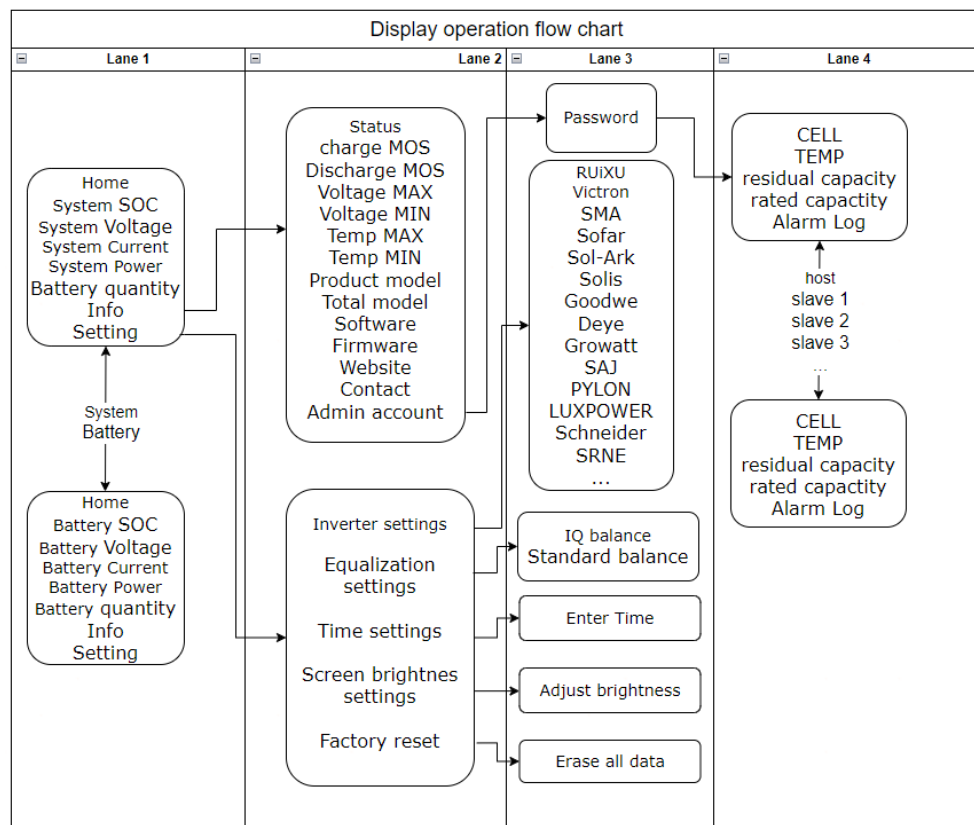



Main screen description

- Host You can click “Battery/System” in the lower left corner to view the system or host parameters.
- The left side of the display shows the current SOC, and the right side shows the parameters related to real-time voltage, real-time current, real-time power, and real-time system online battery number
- Click “Info” below to view basic battery parameters
- Click "Setting" below to set the battery and display

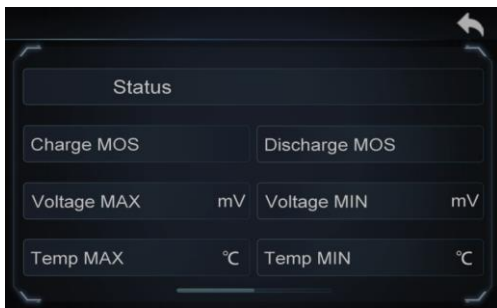

Details Page description

- On the first page, you can view the current status of the battery system, the status of the charge and discharge MOS tube, the highest voltage, the lowest voltage, and the highest and lowest temperature of the battery.
- On the second page, you can view information such as battery model, official website and contact information.



Setting interface Details

- On the Settings screen, you can set the inverter brand, balance mode, time, and screen brightness.
- In the inverter, you can select the current inverter brand. For details about the inverter brand compatible with the battery system, see [Section 3.3.2](#).

3.4 Protection

⚠ CAUTION

Please re-charge the battery via solar, grid/generator or other energy source within 24h if the battery is over discharged.

⚠ NOTICE

Manually short-circuit and reverse the battery will void the warranty.

Items	Description	Remark
Charge End Cell/PACK high-voltage	The BMS will stop charging if any cell or PACK voltage reach the protection value and it will be auto-released only when both Pack and cell voltage back to the release voltage range or there is efficient discharge current	
Discharge End Cell/PACK low-voltage	The BMS will stop discharging if any cell or PACK voltage is under the protection value and it will be released only when all the cell voltage back to the release voltage range or there is efficient charge current	Can Automatic recovery. Please charge timely, otherwise it may be in Low-power mode to be over-discharged.
High temperature	The BMS will stop charging or discharging or both if any cell/environment/MOS temperature is beyond the range.	Automatic recovery
Low temperature	The BMS will stop charging or discharging or both if any cell/environment/MOS temperature is under the range.	Automatic recovery
Charge over- current	The BMS will stop charging when the charging current is higher than the protection value. And it will release from the protection when the system delays time is met.	Automatic recovery. If locked after three consecutive times, manual intervention is required.

Discharge over-current/ Overload	The BMS will stop discharging when the discharging current is higher than the protection value. And it will release from the protection when the system delays time is met	Automatic recovery. If locked after three consecutive times, manual intervention is required.
Short-circuit/Reversed	Short-circuit and Reversed polarity protection happened	Charge to release Manual reset
Temperature, Voltage, Current sensor failure	Enter the failure mode, manual intervention is required no charging and discharging.	Manual intervention
dormancy mode	After reaching a certain condition, it will be in the dormancy mode	Recoverable

3.5 Emergency Power Off

⚠ NOTICE

For details about the installation position and installation specifications of the emergency stop button, see local regulations.

For details on how to check whether the emergency power off is enabled on the battery pack, see Section 3.3.4.

After the SCram function is triggered, restart or reset each battery.

The emergency stop function is triggered by a short circuit in bits 3 and 6 of Link-IN. When wiring the emergency stop button, connect the normally open contact.

If the system is composed of multiple devices, connect the emergency stop button to the battery furthest away from the inverter.



4 Pre-installation preparation









The system installation must be finished by qualified person(s), During the whole installation process, please strictly follow the local safety regulations and related operating procedures.

4.1 Installation environment

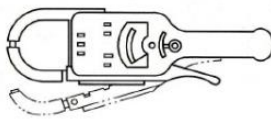
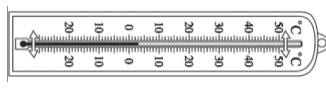
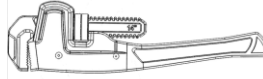
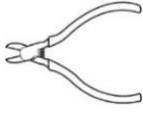
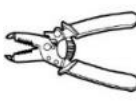
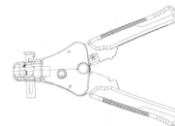
The operating environment shall meet the following requirements:

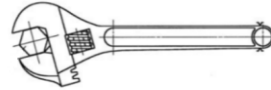
Category	Description
Working temperature	-10°C-50°C(maximum operating range) 15°C-30°C (optimal temperature)
Relative humidity	5%~90%, No condensation
Altitude	<3000m
Safety requirement	<ul style="list-style-type: none">• Do not expose the battery to direct sunlight, rain and snow.• Do not place the battery within children/pet touchable area.• Do not place the battery near heat source and flammable material• Do not place the battery in a closed place where the ventilation is not available.• Do not drop, deform, impact, cut or spearing with a sharp object.• Do not put heavy things on battery.• Do not disassemble the battery without Manufacturer's permission.• No conductive dust and water or other liquid to contact battery.• Follow the emergency measure if there is water invasion or electrolyte and gas leakage.• Contact your supplier within 24 hours if any product failure happens.

4.2 Tool and instrument preparation

Tools and instruments		
Electric forklift	Manual forklift	Multimeter
		
Clamp meters	Thermometer (observe the installation environment)	Crimping pliers
		
Diagonal pliers	Needle nose pliers	Wire stripper
		
Antistatic gloves	Insulated protective Shoes	Wrench
		
Insulating tape	Screwdriver (slot, cross)	cable ties
		

DANGER

- Use insulated tools to avoid electric shock.

NOTICE

- The tools shown are for reference only, please refer to the real thing.
- Due to the different site conditions, this tool list does not fully illustrate a few tools that may be used, so the site installer and the user are requested to prepare for the listed tools according to the actual situation.

4.3 Dismantling of packaging

Unpack precautions

- Please load and unload it in accordance with the specified requirements to prevent sun and rain when you receive the equipment.
- Before batteries are unpacked, check that the packaging is intact, batteries with damaged packaging are not to be used, notify the transporter and manufacturer immediately if damaged.
- Please check and confirm the goods (such as quantity, appearance, etc.) according to the "scope of delivery " before unpacking.
- Do light take and put during unpacking process to protect the surface coating of the object;
- ≥ 4 persons are required to carry the battery module.

Step 1: Use a forklift to transport the product to the designated location.

Step 2: Before unpacking the unit's outer packaging, check the outer packaging for any packaging anomalies or equipment model discrepancies.

Step 3: Use the hammer to open the crate and remove the battery.

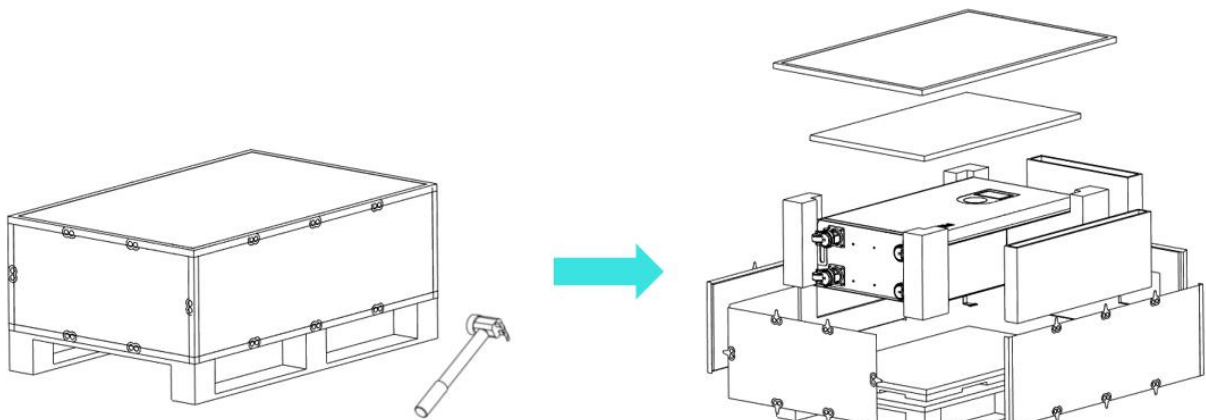

4.4 Checking components

4.4.1 Scope of delivery

⚠ NOTICE

- Keep the unused cable pins NULL to avoid affecting the closed loop communication.
- A ground connection of communication cable may be required from some inverters, please follow the rules from inverter manufacture.
- If batteries are connected in parallel, please use bus bars.
- For inverter communication PIN definition detail, please check [Appendix I](#)

General materials



Battery *1pcs



Manual *1pcs



**WARRANTY
CARD**

Warranty document *1pcs

**shipment
report**

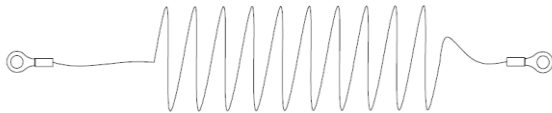
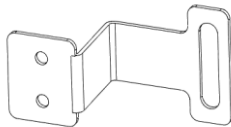
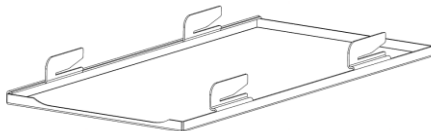

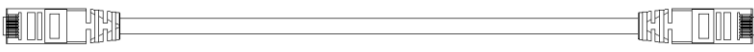

Shipment report*1pcs

Type	Matirial detail	Qty.	Optional length
Components	<p>A: Battery grounding cable</p> 	1pcs	/
	<p>B:Accessories for holding batteries in place</p> 	4pcs	/
	<p>C:Decorative panel</p> 	4pcs	/

	<p>D: Battery to battery communication cable(1000mm)</p> 	1pcs	/
	<p>E: Single device / orange / positive pole</p> 	1pcs	1.4M (φ 10)
	<p>F: Single device / black / negative pole</p> 	1pcs	1.4M (φ 10)
	<p>Hex screw(M6*12) / 1PCS / Components A Expansion screw(M6*50) / 5PCS / Components B pan-head screw(M4*10) / 10PCS / Components B Hex screw(M8*12) / 3PCS / External main cable A/B</p>	/	/

4.4.2 External cable kits

Cables connected to inverter or junction box belongs to an External Cable kits, **NOT include** in battery crate. Customers need buy it separately, the information are as below.

Type	Matirial detail	Optional
External main cable	<p>A: Single device / orange / positive pole</p> 	2M (φ 10)
	<p>B: Single device / black / negative pole</p> 	2M (φ 10)
	<p>C: Connecting bus / orange / positive pole</p> 	2M
	<p>D: Connecting bus / black / negative pole</p> 	2M

5 Installation

Qualified person

5.1 Matters need attention

CAUTION

Injuries may result if the product is lifted incorrectly or dropped while being transported or mounted. Wear suitable personal protective equipment for all work on the product.

Ensure that no lines are laid in the wall which could be damaged when drilling holes.

Please check again the following conditions or equipment whether meet the requirements before installation:

- Check if there's enough space for installation, and if the load-bearing capacity of the installation site meets the weight requirements
- Check whether the power cable pair(s) used meets the maximum current requirement for operation;
- Check whether the overall layout of power supply equipment and batteries at the construction site is reasonable;
- Check whether the installer is wearing anti-static wristband
- Check that there are at least two people at the construction site to perform installation work
- Check if there's potential risks at location of installation site, e.g flooding, sun exposure, corrosion, and salt spray

5.2 Battery mounted

⚠ WARNING

- During the lifting process, ensure that the angle between the two cables is not greater than 90°, as shown in the figure below.
- Before installing the battery, make sure that the power supply switch is turned OFF.
- Do not place installation tools, metal parts, or sundries on the battery during installation. After installation, clean up the battery and its surroundings in a timely manner.
- Do not remove the protective parts of the battery terminals, such as the protective cover or waterproof cap, when handling the battery.
- Do not move or operate under the forklift arm.
- If you need to move devices manually, ensure that at least four people move the devices together.

⚠ NOTICE

Leave a gap of 30cm above the battery for cable routing.

Reserve a fixed position above the battery to help fix the cable harness to prevent long-term stress damage.

Operational procedure:

Step 1: According to the design requirements, determine the installation position of the battery on a flat ground and draw a line mark.

Step 2: Find the hoisting holes, use forklifts, cranes and other transportation tools to transport the battery cabinet to the designated location, and install it at the marked location.

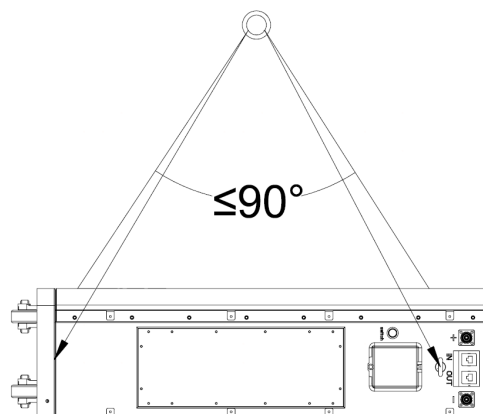

Step 3: After placing the battery in the designated position, use battery accessories to secure it to the wall and adjust the bottom wheel to fixed mode.



Battery fixation diagram



wheel fixing method

Installation of multiple battery systems:

When multiple battery systems are installed in parallel, the spacing between the battery systems must be at least 150mm, and use battery accessories to fix them to the wall.

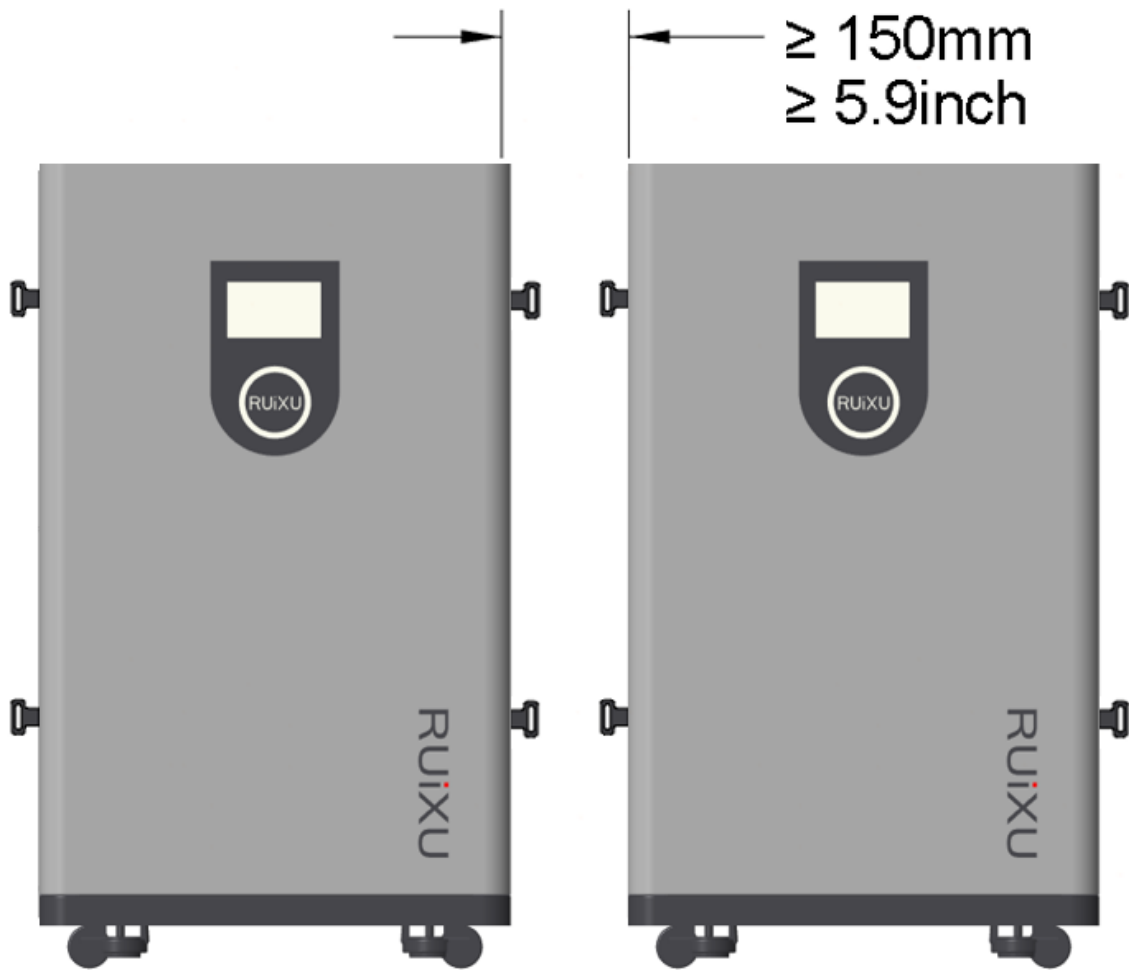

6. Cable connection and commissioning

Qualified person

DANGER

- Pay attention to the positive and negative terminals during installation, it is strictly prohibited to short-circuit the positive and negative terminals, otherwise it will cause a short circuit of the battery.
- Wear insulated gloves and use insulated tools to avoid electric shock injury or short circuit failure.
- Do not smoke or use open flame near the battery.

NOTICE

- The colors of the cables involved in all the electrical connection schematics in this section are for reference only, and the cables should be selected in accordance with local standards.
- if you are making cable yourself, please follow manufacturer's requirements.

6.1 Cable connection

Step 1: Get battery ready

- Ensure battery is in OFF mode, and confirm the installation is tighten and stable.
- Check the number and specification of cable kit accessories are correct according to the Scope of delivery item.

Step 2: Grounding cable connection

- Take the ground cable and corresponding screw out of the fitting.
- Ground the battery cover using a screwdriver and ground cable.

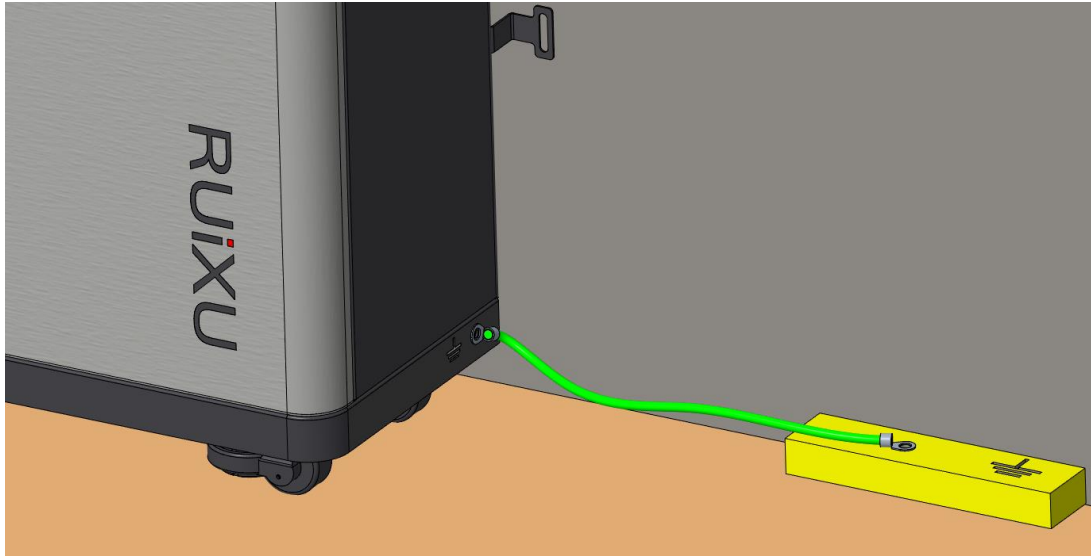

Step 3: Communication cable connection

If the system is used in parallel, connect the communication cable.

- Take out battery to battery communication cable.
- Confirm the location of Master battery, insert the RJ45 plug into the Link IN port and connect the other side to next battery Link Out port, daisy chained all batteries.

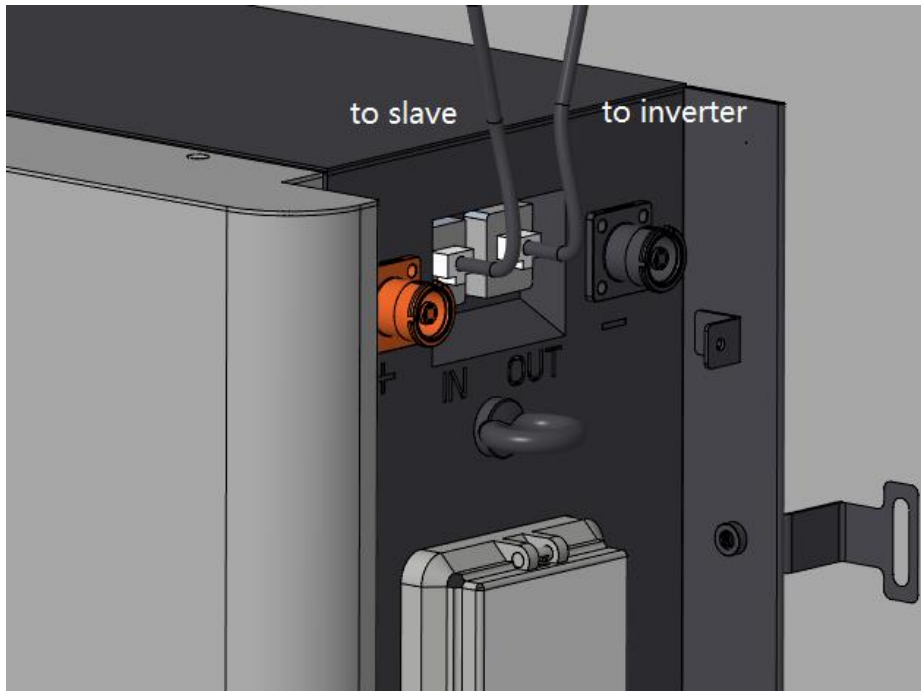

Host connection mode

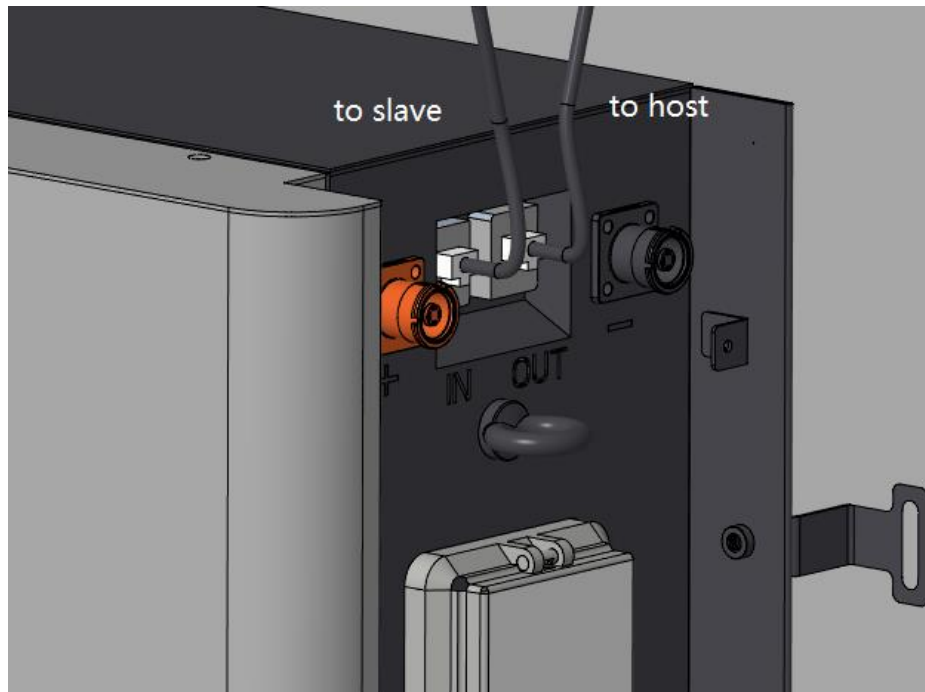

Slave connection mode

Step 4: DC power cable connection

- Take out battery to battery power cable.
- Insert the Plug into the power socket until you hear the snapping sound.

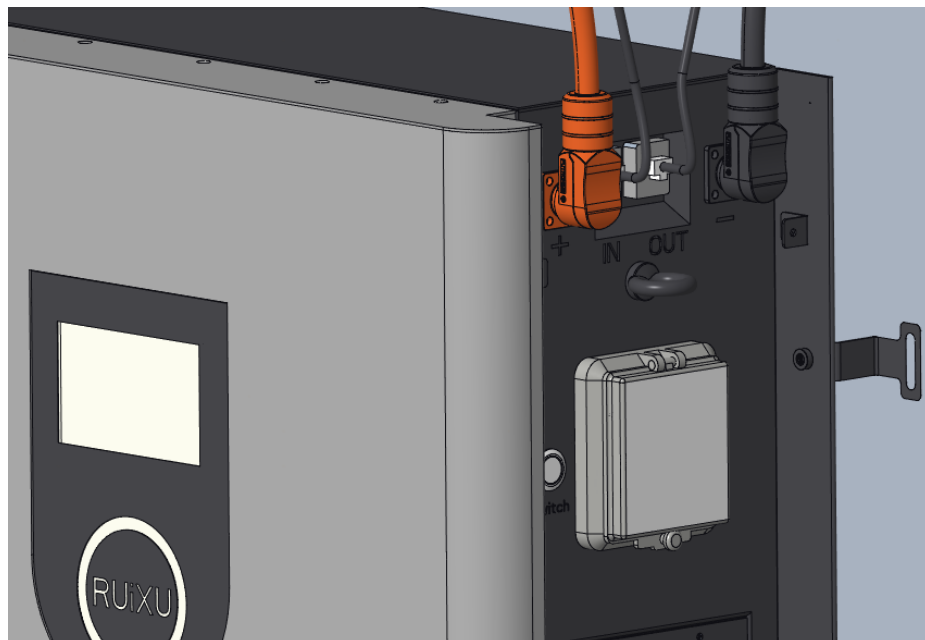

Power line connection

If batteries are connected in parallel, please use bus bars. Suggestions for parallel busbars are as follows.

- The carrying capacity of the bus meets the peak power of the inverter, the conductor has the ability of oxidation resistance and corrosion resistance, and the bus bar needs to have insulation protection measures.
- The position of the inverter connected to the bus is the same distance from the position of the multiple connected batteries.
- The fixing hole of the bus bar is M8, which is fixed by screws with anti-loosening measures such as flange or spring flat washer combination screw.

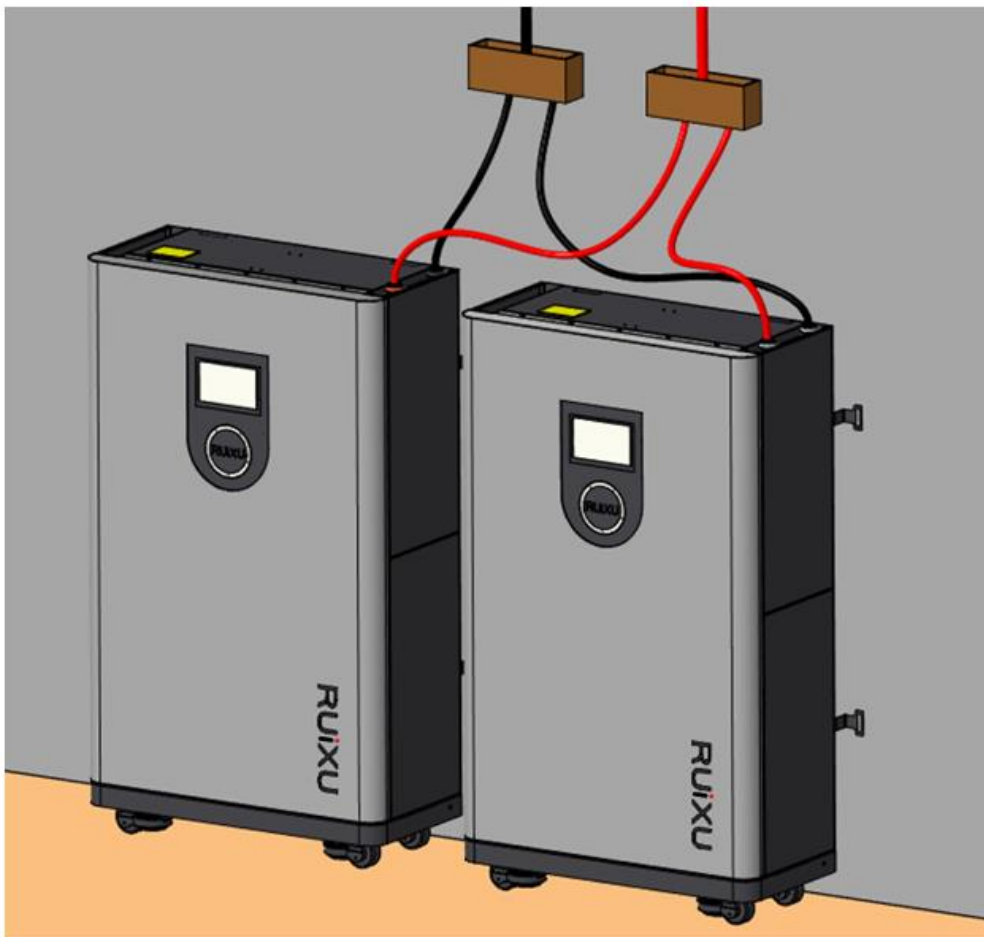

NOTICE

- Before connecting the battery system in parallel, ensure that the SOC of the battery system is as consistent as possible

Step 5: Connecting with inverter

⚠ CAUTION

- Confirm inverter AC input and PV input is disconnected before wiring connection, and the DC/ signal switch of inverter/charger is in off status.
- The maximum permissible current of each power cable and terminal is 240A, The continuous allowable current is 200A.
- please use corresponding number of power cable pairs according to the field configuration and local connection requirements, standards, and directives.

⚠ NOTICE

- The maximum communication cable length is required to be less than 15m between inverter/charge and battery.
 - The maximum power cable length is suggested to be less than 10m between inverter/charge and battery.
 - When the battery is used in parallel, use a bus bar to connect the battery to the inverter.
 - Please refer to Appendix I for the communication connection method
- Connecting Master battery Link Out port with inverter CAN or RS485 communication port via inverter communication cable,.
 - Connecting battery OUTPUT (+) with inverter battery INPUT (+), battery OUTPUT (-) with inverter battery INPUT (-), choose the corresponding power cable pair and wiring them correctly.

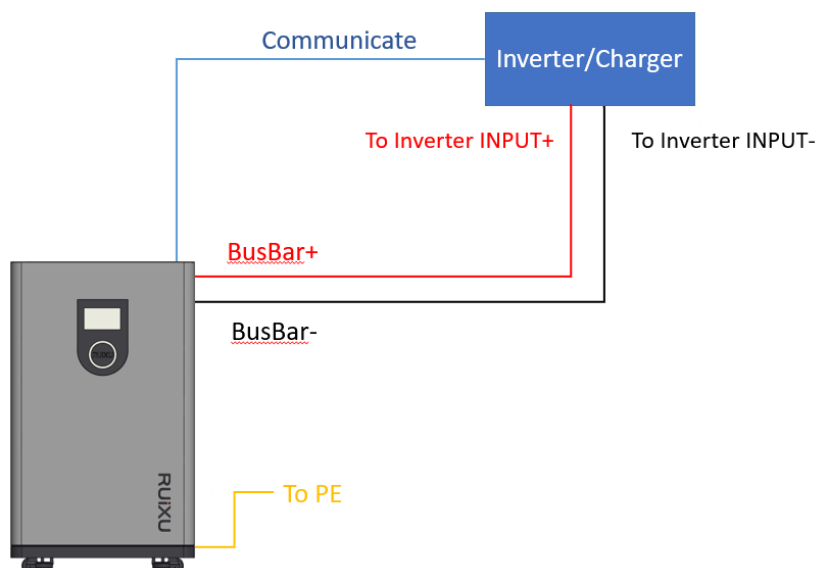

6.2 Commissioning

⚠ CAUTION

If your system is an back-up or off-grid system, make sure your configuration can cover the worst situation to avoid battery to be over-discharged.

Step 1: Turn on the breaker in battery, then turn on the inverter/charger isolator.

Step 2: Hold down the switch button of the battery for 3s to start the battery.

Step 3: Set the corresponding inverter brand on the battery display.

Step 4: Finish the setting on inverter/charger or any other control devices, if everything is correct, you are ready to use

6.3 Switch off battery

Step 1: Turn off the inverter.

Step 2: Hold down the switch button on the battery for 3s to turn off the battery.

Step 3: Turn off the breaker in battery.

6.4. Troubleshooting

Items	Solution	Measure
Unable to start	<ol style="list-style-type: none"> 1. Switch on battery and press RESET 6s to observe whether the battery can be started. 2. Charge the battery use a charge or inverter to provide 54~57.6V voltage and observe it can be started. 	If the abnormal status still alive after above steps, please contact your supplier.
Unable to charge	<ol style="list-style-type: none"> 1. Check whether the cable connection between the battery and the inverter/charger is correct. 2. Check whether the inverter/charger setting is correct. 3. Check whether the battery is in charge protection mode, if yes, try to discharge the battery. 	

<p>Unable to discharge</p>	<ol style="list-style-type: none"> 1. Check whether the cable connection between the battery and the inverter/charger is correct 2. Check whether the battery occurs short circuit, reverse connection, pre-charge failure during connection inverter etc. 3. Check whether the battery is in discharge protection mode, if yes, try to charge the battery. 	<p>If there is any other situation(s) excluding in this table, turn off the fault battery, contact your supplier.</p>
<p>High/Low temperature</p>	<ol style="list-style-type: none"> 1. Stop the battery system for a while, check whether the installation location temperature meet the requirement. 2. Avoid continuous full charging and discharging 	
<p>High current</p>	<p>Check the configuration and parameters setting on the inverter/charger is correct.</p>	
<p>ALM always on</p>	<p>Turn off all the batteries, and remove the fault battery from the system.</p>	
<p>Communication fail</p>	<ol style="list-style-type: none"> 1. Check the communication cable type is correct and is contacted well. 2. Check the inverter protocol related setting is correct. 3. Check both battery and inverter are working properly. 	

 **NOTICE**

Please restart after software upgrade.

6.4. Fuse replacement

Fuse parameter:

$70\text{VDC} \leq \text{Voltage}$;

$250\text{A} \leq \text{Electricity} \leq 300\text{A}$;

When the current is greater than 3000A, the fuse fuse time is less than or equal to 500us;

Steps to replace:

Step 1: Open the battery system repair window.

Step 2: Remove the old fuse.

Step 3: Install new fuses.

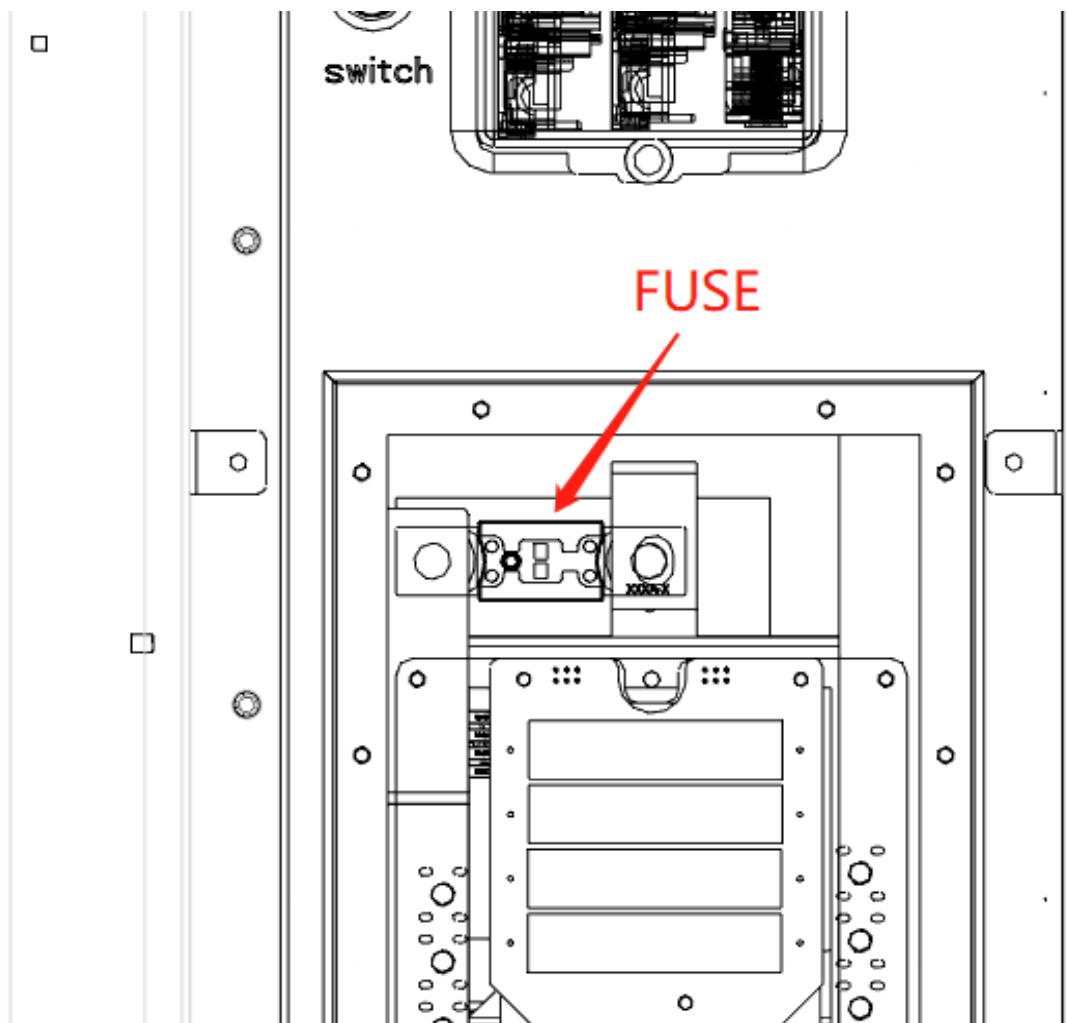

7. Transport, Storage

- Do not violently shake, impact or squeeze, and prevent sun and rain during the transportation.
- Do light take and put and strictly prevent falling, rolling, and heavy pressure during loading and unloading.
- The battery should be placed in a dry, clean, dark, and well-ventilated indoor environment for long-term storage, and the recommended storage temperature range is 15~30°C.
- No harmful gases, flammable and explosive products and corrosive chemical substances in the storage location.
- The batteries should be stored and transported in close to 50% SOC, do not store over 80%SOC for long time.
- If do not use for a long time, the battery needs to be charged every 6 months.
- Do not bump, do not stack, keep upright or face up.
- No items are allowed to be placed above the battery.

8. Disposal of battery

Disposal of battery must comply with the local applicable disposal regulations for electronic waste and used batteries, please review your local Battery recycling or management regulations or contact RUIXU for more information.

Appendix I

NOTICE

- The communication connection method is for reference only. If the connection definition is inconsistent with the inverter organ connection, please refer to the inverter organ connection.
- For the connection methods of some inverter brands, refer to Appendix II.

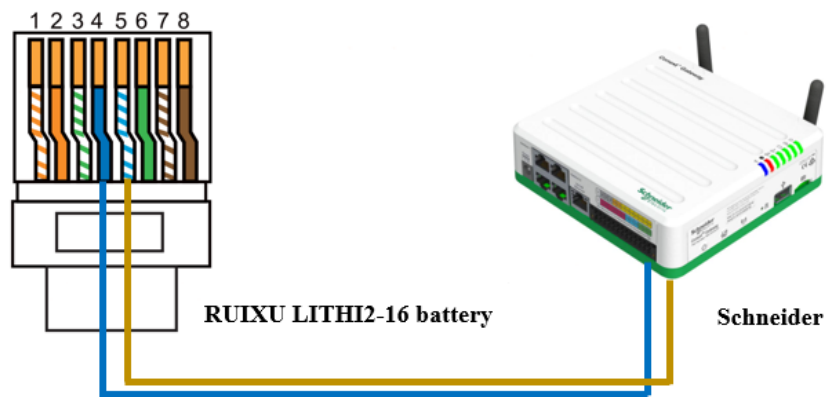

Battery Link IN port	Conext Gateway	Cable suggest
Pin4	Pin14	customized
Pin5	Pin12	
Pin6 (optional)	Pin10 (optional)	

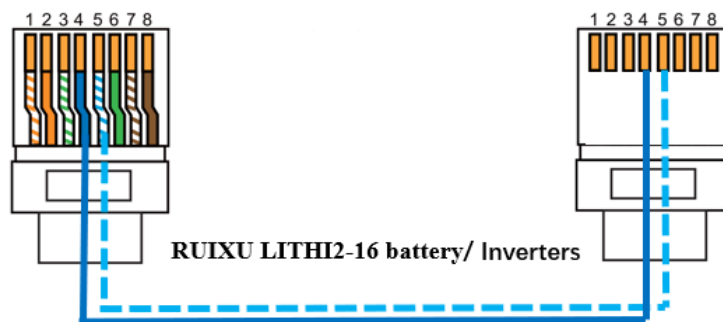

Definition	Battery Link IN port	Inverter communication	Cable suggest
CAN H	Pin4	Pin4	Version-I(CAN)
CAN L	Pin5	Pin5	

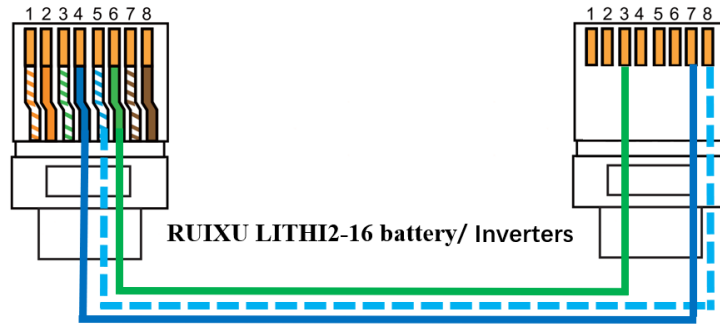

Definition	Battery Link IN port	Inverter communication	Cable suggest
CAN H	Pin4	Pin7	Version-II (CAN)
CAN L	Pin5	Pin8	
GND	Pin6	Pin3	

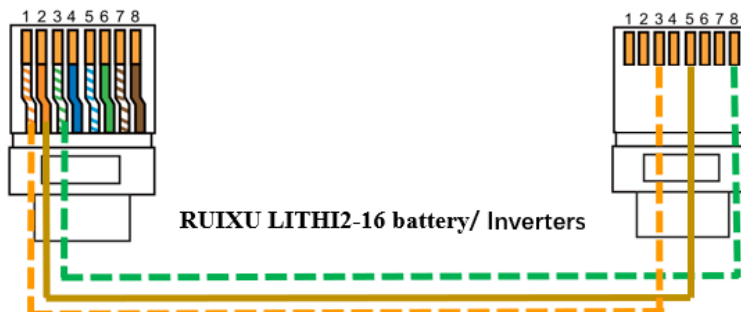

Definition	Battery Link IN port	Inverter communication	Cable suggest
RS485-B	Pin1	Pin3	Version-III (RS485)
RS485-A	Pin2	Pin5	
GND	Pin3	Pin8	

Appendix II

ID	Inverter brand	Cable suggest
1	Sol-Ark/Solis/ Goodwe/ Deye/ Megarevo/ LUXPOWER/	Version-I(CAN)
2	Victron/	Version-II(CAN)
3	Voltronic/ MPP/	Version-III (RS485)
4	Schneider	Appendix I
5	SRNE	Ethernet cable

